

**3M 520-01-84R01**  
**R-Series Welding Headgear Assembly**  
*User Instructions*

For use with BE-17, AH-17, AH-31, AH-33, and AH-39 Systems.

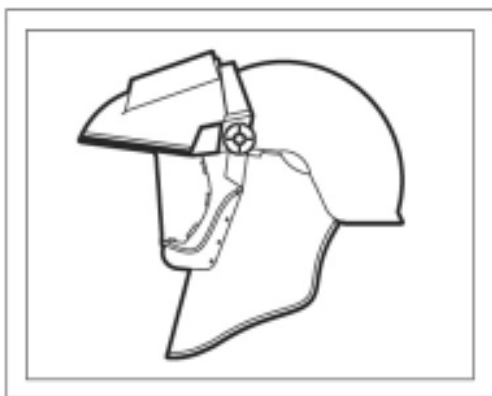

**Important:** Read and understand all safety information before operating.

## TABLE OF CONTENTS

SECTION 1 .....	4
Safety Guidelines.....	4
Intended Use.....	4
Index of Warnings and Cautions .....	4
NIOSH Approvals .....	6
NIOSH Cautions and Limitations .....	6
General Description.....	7
Use For.....	7
Do Not Use For.....	7
Respirator Selection.....	7
Respirator Training.....	7
Eye and Face Protection .....	8
Assigned Protection Factors .....	8
SECTION 2 .....	9
Specifications.....	9
SECTION 3 .....	10
System Components and Replacement Parts .....	10
NIOSH Approved Respirator Systems.....	10
3M™ R-Series Welding Headgear System .....	10
3M™ R-Series Welding Headgear Assemblies and Components.....	10
3M™ R-Series Welding Headgear Airline Components.....	11
SECTION 4 .....	12
Assembly .....	12
Tyvek® Faceseal .....	12
Welding Filter Lens Assembly.....	12
Welding Shield Assembly.....	13
Visor Surround.....	13
Visor.....	13
Neck Protector.....	14
Comfort Band.....	15
Headband and Cradle Assembly .....	15
Headseal .....	16
Temple Seals .....	16
Ratchet Pivot Support.....	16
Flowstream Valve Assembly, Sintered Bronze Disk.....	17
Donning the System.....	17
Connecting the Headpiece to the PAPR Filtration/Blower Unit or Supplied Air System.....	18
SECTION 5 .....	20
Operating Instructions .....	20
User Performance Check.....	21
Airline Systems Only .....	21
Adjusting the Belt Length.....	22
Compressor Requirements for the Airline Systems.....	22
SECTION 6 .....	23
Inspection and Cleaning.....	23
Cleaning the 3M™ R-Series Welding Headgear.....	23

Inspecting the 3M R-Series Welding Headgear.....	23
SECTION 7 .....	25
Troubleshooting.....	25
SECTION 8 .....	26
Important Notice:.....	26

For ordering information and the location of the 3M authorized distributor in your area, call 1-800-328-1667.

For assistance with the operation and application of products from 3M Occupational Health and Environmental Safety Division (OH&ESD), please call your 3M representative at 1-800-896-4223 or call 3M Technical Service at 1-800-243-4630. In Canada, call Marketing at 1-800-265-1840, ext. 6137 or Technical Service at 1-800-267-4414.

**SAVE THIS *USER INSTRUCTIONS* AND KEEP IT WITH THE RESPIRATOR.**

## SECTION 1

### Safety Guidelines

#### Intended Use

3M™ R-Series Welding Headgear is a lightweight, positive pressure, loose fitting facepiece respirator. The 3M R-Series welding headgear, when combined with an appropriate air supply/filtration system, is designed to provide respiratory protection against certain particulates, organic vapors, acid gases and other inorganic gases.

3M R-Series welding headgear are approved for use with certain 3M™ Powered Air Purifying and Airline Respirator Systems. These respirators are intended to be used for respiratory protection against certain particulates, organic vapors, acid gases and other inorganic gases. OSHA respirator standard 29 CFR 1910.134 requires that... “The employer shall establish and implement a written respiratory protection program with worksite specific procedures. The program shall be updated as necessary to reflect changes in workplace conditions that affect respirator use...” All applicable provisions of this standard must be complied with prior to respirator use.

#### Index of Warnings and Cautions

### WARNING

- This product helps protect against certain airborne contaminants. **Misuse may result in sickness or death.** For proper use, see supervisor or instructions, or call 3M in U.S.A., 1-800-243-4630. In Canada, call Marketing at 1-800-265-1840, ext. 6137 or Technical Service at 1-800-267-4414.
- The inner visor of the 3M R-Series welding headgear provides secondary eye and face protection only. When exposed to eye and face hazards, the respirator wearer must wear additional eye and/or face protectors appropriate to the hazard.
- Use only 3M parts and accessories for the 3M R-Series welding headgear as described in these *User Instructions*.
- Do not reach your hand into the facepiece in areas where the air is contaminated. Leave the contaminated area and clean contaminants from your hands before reaching inside the headgear.
- For proper application of this product, consult an industrial hygienist or call 3M OH&ESD technical service department at 1-800-265-1840, ext. 6137 or Technical Service at 1-800-267-4414.
- Each person using a 3M R-Series welding headgear respirator must read and understand the information in these *User Instructions* before use. Use of these respirators by untrained or unqualified persons, or use that is not in accordance with these *User Instructions*, may adversely affect respirator performance and result in sickness or death.
- These respirators do not provide eye or face protection. When exposed to eye and face hazards, you must wear eye and/or face protection appropriate to the hazard. Failure to do so may result in serious bodily injury or death.
- The welding headgear is supplied without a welding filter lens. An appropriate welding filter lens must be installed before this system may be used for welding operations. Failure to do so may result in serious eye injury.
- Incorrect fitting of the visor will reduce face, eye and respiratory protection, and may result in the risk of serious bodily injury or death.
- Incorrect fitting of the headband and cradle assembly will reduce head protection and could possibly render the headgear totally ineffective, resulting in serious bodily injury or death.
- The user must read and follow all *User Instructions* supplied with the PAPR motor blower or supplied air equipment. Incorrect operation of the PAPR motor blower or supplied air system could result in reduced airflow, interruption of airflow to the headpiece or contamination of breathing air and may result in sickness or death.
- Read and follow the *User Instructions* supplied with the PAPR blower unit. Complete

the pre-use inspection and user performance test specified by the PAPR *User Instructions* before attaching the PAPR motor blower to the headpiece. Failure to do so may result in sickness or death.

- Use of these respirators by untrained or unqualified persons, or use not in accordance with these *User Instructions* may adversely affect respirator performance and result in sickness or death. Refer to additional warnings listed in the Safety Guidelines Section.
- Use of these respirators must be in accordance with applicable safety and health standards, respirator selection tables contained in such publications as ANSI Z88.2-1992, or pursuant to the recommendations of an industrial hygienist. A written respirator program must be in place, which is in accordance with the OSHA respiratory protection standard found in 29 CFR 1910.134 prior to using any respirator.
- Before use, the user must be trained by the employer in the proper use and maintenance of the 3M R-Series welding headgear respirator. Such training must be in accordance with these *User Instructions*. Each person using these respirators must first read and understand these entire *User Instructions*. Failure to do so may result in sickness or death.
- The welding shield of the 3M R-Series welding headgear is not designed to be raised or lowered by nodding the head. Using the 3M R-Series welding headgear in this manner can result in neck injury and can damage the ratchet pivot system.
- The 3M R-Series welding headgear is not designed for use in arc-air welding or other high-heat applications.
- Always don the respirator in a non-contaminated area. Failure to properly don this respirator before entering a hazardous atmosphere may result in sickness or death.
- Before you enter a hazardous atmosphere wearing this respirator, you must inspect the respirator, complete a user performance check, and don the respirator according to the instructions in the Assembly Section. Failure to do so may affect respirator performance and may result in sickness or death. Do not wear this respirator headpiece to enter areas where atmospheric concentrations of contaminants are unknown, immediately dangerous to life or health, exceed the Maximum Use Concentration (MUC\*) for the respirator system, or where atmospheres contain less than 19.5% oxygen.  
\*MUC is equal to the respirator's Assigned Protection Factor (25) times the Permissible Exposure Limit for the contaminant.
- Breathing air must meet at least the specification for Grade D breathing air, as described in the Compressed Gas Association Commodity Specification G-7.1-1989 in the United States and Table 2 of the CSA standard CAN3-Z180.1-M85 in Canada.
- Airline couplings shall be incompatible with outlets for other gas systems to prevent inadvertent servicing of airline respirators with nonrespirable gases or oxygen in accordance with OSHA standard 29 CFR 1910.134(d)(3). Failure to do so may result in sickness or death.
- If the respirator fails any of the requirements of the user inspection and performance check, do not use the respirator until all necessary repairs have been made and the respirator passes the performance check. Failure to do so may adversely affect respirator performance and result in sickness or death.
- Do not remove the respirator while you are in a hazardous atmosphere. Contaminants which are dangerous to your health include those which you may not be able to see or smell. Failure to do so may result in sickness or death. Leave the contaminated area immediately if:
  - Any part of the system becomes damaged
  - Airflow into the respirator decreases or stops
  - Breathing becomes difficult
  - You feel dizzy or your vision is impaired
  - You taste or smell contaminants
  - Your face, eyes, nose or mouth become(s) irritated
  - You suspect that the concentration of contaminants may have reached levels at which this respirator may no longer provide adequate protection.
- Remove the respirator in a clean area. Clean your hands of any contaminants before reaching inside the facepiece for any reason. Refer to the Cleaning and Inspection Section for cleaning, inspection and storage information.

- If excessive wear and/or damage to the respirator or its components is observed at any time, do not use the respirator until all necessary repairs have been made and the wearer has successfully completed the user performance check described in the Operating Instructions Section. Failure to do so may result in sickness or death.
  - Do not clean headgears with detergents that contain lanolin or other oils since they may soften or distort the faceshield.
  - Do not wipe the faceshield with strong solvents such as MEK, acetone, toluene, as those may damage or distort the faceshield.
  - Do not soak headgears or components in cleaning solutions or solvents.
  - Misuse may adversely affect respirator performance and may result in sickness or death.
  - If you discover any of the wear and damage described below, discard the component and replace it with a new one. Failure to do so may adversely affect respirator performance and result in sickness or death.
- 

**Note:** Refer to the *User Instructions* provided with the 3M blower/filtration unit and chemical cartridge/filters for specific use limitations.

### **NIOSH Approvals**

For a listing of the components of NIOSH approved 3M™ Respirator Systems using the 3M™ R-Series Welding Headgear, refer to the NIOSH approval label insert.

### **NIOSH Cautions and Limitations**

#### **Powered Air Purifying Respirator Systems Using 3M R-Series Welding Headgear**

- A – Not for use in atmospheres containing less than 19.5 percent oxygen.
- B – Not for use in atmospheres immediately dangerous to life or health.
- C – Do not exceed maximum use concentrations established by regulatory standards.
- F – Do not use powered air-purifying respirators if airflow is less than four cfm (115 lpm) for tight fitting facepieces or six cfm (170 lpm) for hoods and/or helmets.
- H – Follow established cartridge and canister change schedules or observe ESLI to ensure that cartridges and canisters are replaced before breakthrough occurs.
- I – Contains electrical parts which have not been evaluated as an ignition source in flammable or explosive atmospheres by MSHA/NIOSH.
- J – Failure to properly use and maintain this product could result in injury or death.
- L – Follow the manufacturer's User's Instructions for changing cartridges, canister and/or filters.
- M – All approved respirators shall be selected, fitted, used, and maintained in accordance with MSHA, OSHA, and other applicable regulations.
- N – Never substitute, modify, add, or omit parts. Use only exact replacement parts in the configuration as specified by the manufacturer.
- O – Refer to User's Instructions, and/or maintenance manuals for information on use and maintenance of these respirators.
- P – NIOSH does not evaluate respirators for use as surgical masks.

#### **Powered Air Purifying Respirator Systems Using 3M R-Series Welding Headgear**

- B – Not for use in atmospheres immediately dangerous to life or health.
- C – Do not exceed maximum use concentrations established by regulatory standards.
- D – Air-line respirators can be used only when the respirators are supplied with respirable air meeting the requirements of CGA G-7.1 Grade D or higher quality.
- E – Use only the pressure ranges and hose lengths specified in the User's Instructions.
- J – Failure to properly use and maintain this product could result in injury or death.
- M – All approved respirators shall be selected, fitted, used, and maintained in accordance with MSHA, OSHA, and other applicable regulations.

N – Never substitute, modify, add, or omit parts. Use only exact replacement parts in the configuration as specified by the manufacturer.

O – Refer to User's Instructions, and/or maintenance manuals for information on use and maintenance of these respirators.

### **General Description**

The 3M™ R-Series Welding Headgear is a NIOSH-approved, loose fitting headgear which can be combined with a number of positive pressure air filtration/supply systems to form a complete powered air purifying respirator (PAPR) or supplied air respirator (SAR) system.

Breathing air supplied by the filtration/supply system is fed into the rear of the headgear assembly, passed around the user's head, and directed downward over the forehead, providing fresh air for the forehead and face.

The welding shield is intended to be used with the auto-darkening lens (sold separately). The welding shield is held up by a ratchet-pivot mechanism, which holds the welding shield in a fully open, half open or fully closed position. Two interlocking ratchet plates hold the welding shield in one of the three positions. A knob on each side of the headgear permits the user to easily adjust the amount of tension holding the shield. (Figure 1)



### **Use For**

Respiratory protection against certain airborne contaminants including particulates (dusts, fumes, mists, radionuclides and asbestos); organic vapors; acid gases; and other inorganic gases. Refer to instructions packaged with the appropriate cartridge/filter media for more information on use limitations.

### **Do Not Use For**

Atmospheres where oxygen concentration is below 19.5%. Where concentrations of contaminants are unknown; immediately dangerous to life or health (IDLH); exceeds applicable local standards or OSHA standards, whichever is lower. Refer to additional limitations and cautions under NIOSH Cautions and Limitations.

### **Respirator Selection**

3M R-Series welding headgear respirators must be used in accordance with applicable health and safety standards, respirator selection tables contained in such publications as ANSI standard Z88.2-1992, or pursuant to the recommendations of an industrial hygienist. A written respirator program must be in place which is in accordance with the OSHA respiratory protection standard found in 29 CFR 1910.134 prior to using any respirator.

### **Respirator Training**

Before using 3M R-Series welding headgear respirators, the employer must assure that each respirator user has been trained by a qualified person in the proper use and maintenance of the respirator according to the instructions contained in these *User Instructions* and other applicable *User Instructions*.

## WARNING

Each person using a 3M R-Series welding headgear respirator must read and understand the information in these *User Instructions* before use. Use of these respirators by untrained or unqualified persons, or use that is not in accordance with these instructions, may adversely affect respirator performance and result in sickness or death.

---

### **Eye and Face Protection**

## WARNING

These respirators do not provide eye or face protection. When exposed to eye and face hazards, the respirator wearer must wear eye and/or face protection appropriate to the hazard. Failure to do so may result in serious bodily injury or death.

---

### **Assigned Protection Factors**

3M recommends an assigned protection factor (APF) of 25 for loose fitting facepiece respirators. Where local, state, or federal standards specify APFs, the lowest applicable APF should be used.



## SECTION 2

### Specifications

Airflow range –	6 to 15 scfm (170 to 425 lpm)
Weight –	Welding headgear assembly: Approximately 2 pounds Breathing tube assembly: Approximately 0.5 pounds Flowstream: Approximately 1 pound Vorstream: Approximately 1.5 pounds Coldstream: Approximately 1.5 pounds
Breathing tubes –	Length: 14 inches and 17 1/2 inches Made of EPDM rubber
Inner faceshield dimensions –	Inner shield: 47 square inch (305 cm <sup>2</sup> )
Faceshield material –	Polycarbonate
Welding shield –	Accepts 4 1/2 inches x 5 1/4 inches welding filter lens
Head protection –	Welding headgear meets the requirements of ANSI Z89.1-1997, Type I, Class E

### Airflow with Airline Control Valves

Flowstream –	Airflow will not exceed 15 cfm when using 25 feet of air supply hose and supplying 70 psig of breathing air to the flowstream valve.  Airflow will not drop below 6 cfm when using 300 feet of air supply hose and supplying 55 psig of breathing air to the flowstream valve.
Vorstream –	Airflow will not exceed 12 cfm when using 25 feet of air supply hose and supplying 120 psig of breathing air to the vorstream tube.  Airflow will not drop below 6 cfm when using 100 feet of air supply hose and supplying 75 psig of breathing air to the vorstream tube.
Coldstream –	Airflow will not exceed 12 cfm when using 25 feet of air supply hose and supplying 115 psig of breathing air to the coldstream tube.  Airflow will not drop below 6 cfm when using 100 feet of air supply hose and supplying 70 psig of breathing air to the coldstream tube.

## SECTION 3

### System Components and Replacement Parts

#### NIOSH Approved Respirator Systems

For a listing of the components of a NIOSH approved 3M™ Respirator System using 3M™ R-Series Welding Headgear, refer to the NIOSH approval label insert.

#### 3M™ R-Series Welding Headgear System

##### 3M R-Series Welding Headgear Assemblies and Components

Figure Number	Part Number	Description
1	520-03-54R01	Welding Headgear Shell Assembly
2	061-68-04R01	Hook and loop Fastener Set (use w/Neck Protector)
3	060-28-03R01	Headseal
4	060-49-02R10	Temple Seal, pair (pack of 10)
5	060-32-04R01	Cradle Assembly
6	060-38-02R01	Headband
7	060-38-01R10	Comfort Band (pack of 10)
8	527-01-24R01	Neck Protector (Nomex®)
9	520-02-26R01	Visor Surround Assembly
10	522-01-01R10	Visor (pack of 10)
11	061-36-01R01	Filter Lens Retaining Clip (plastic)
11, 12, 13	520-02-27	Filter Lens Assembly
12	060-32-04R01	Anti-Spatter Cover Lens
13	061-35-01R01	Lens Gasket
14	061-31-01R01	Welding Shield
15	529-02-38R01	Radiant Heat Guard

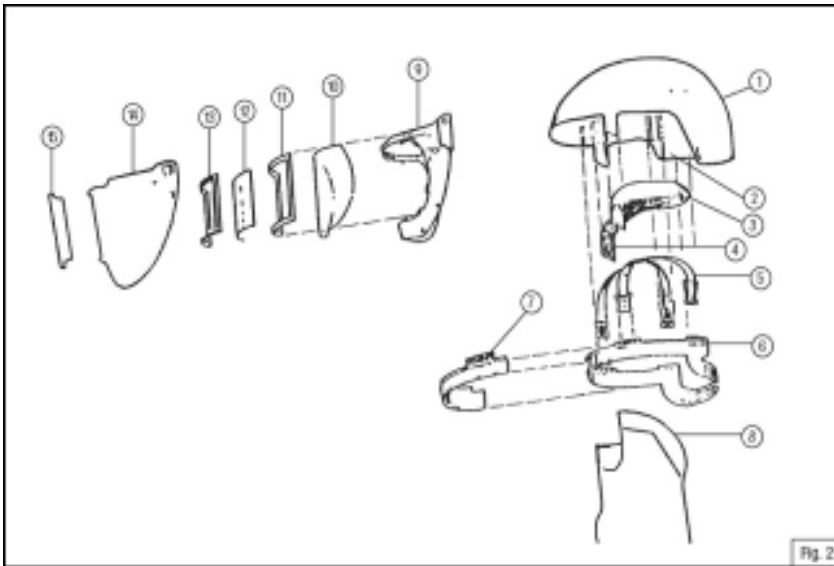

##### 3M™ R-Series Welding Headgear Assemblies and Components

Part Number	Description	Part Number	Description
520-01-84R01	3M R-Series Welding Headgear Assembly	061-68-04R01	Hook and Loop Fastener Set (use w/Neck Protector)
061-32-04R01	Anti-Spatter Cover Lens	522-01-01R10	Visor (pack of 10)

060-39-01R10	Comfort Band (pack of 10)	520-02-26R01	Visor Surround Assembly
060-32-04R01	Cradle Assembly	520-03-54R01	Welding Headgear Shell Assembly w/Adapter Plate (includes catch)
520-02-27	Filter Lens Assembly		
520-04-51	Welding Shield Ratchet Pivot Replacement/ Upgrade Kit	061-31-01R01	Welding Shield
061-36-01R01	Filter Lens Retaining Clip (plastic)	526-01-10R01	Breathing Tube Assembly (14 inch length)
060-38-02R01	Headband	526-01-13R01	Breathing Tube Assembly (17 1/2 inch length)
060-28-03R01	Headseal	522-02-30R01	Electronic Lens Assembly, shade range continuously variable from 9 to 12 (2.75 when off)
061-35-01R01	Lens Gasket	522-01-04R01	Visor, Hard-Coated
527-01-24R01	Neck Protector, Nomex®	529-02-37R10	Protective Overlay, Clear (pack of 10)
529-02-38R01	Radiant Heat Guard		
527-01-19R10	Sontara® Disposable Full Facesal (pack of 10)		
060-49-02R10	Temple Seal, Pair (pack of 10)		

### **3M™ R-Series Welding Headgear Airline Components**

<b>Part Number</b>	<b>Description</b>	<b>Part Number</b>	<b>Description</b>
524-01-12R01	Belt	529-01-22R01	Coldstream Tube Assembly
520-02-90R01	Belt (w/plastic buckle)	529-01-24R01	Vorstream Tube Assembly
520-01-08R01	Breathing Tube Assembly	526-01-21	Air Supply Hose 25 ft w/Hansen
529-01-13R10	Gasket for Breathing Tube (pack of 10)	526-01-11	Air Supply Hose 50 ft w/Hansen
529-01-27R01	Pad (Coldstream/Vorstream)	526-01-06	Air Supply Hose 100 ft w/Hansen
525-01-72R01	Retaining Ring (Bronze Disk, Flowstream)	526-01-00	Coiled Hose 25 ft w/Hansen
525-01-12R01	Sintered Bronze Disk (Flowstream Valve)	526-01-09	Coiled Hose 50 ft w/Hansen
520-01-27R01	Flowstream Valve Assembly	526-01-07	Coiled Hose 100 ft w/Hansen

## SECTION 4

### Assembly Tyvek® Face Seal

#### Removal

Raise the visor surround to the horizontal position. Hold the headband away from the temple seals, and unhook and pull the elastic loops from the headband. Remove the face seal from each of the studs, and unhook the center elastic loop from the lug on the front of the visor surround. (Figures 3A-3D)

#### Replacement

Attach the face seal to the visor surround as follows: hook the center elastic loop over the lug at the front center of the visor surround. Fit each of the holes along the edge of the face seal over each of the studs on the visor surround.

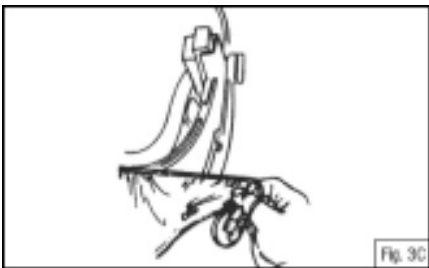
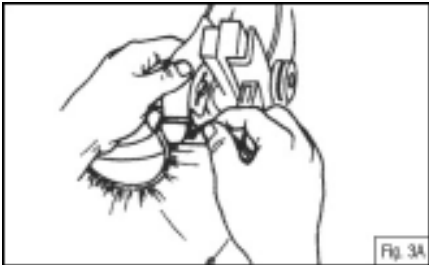

### Welding Filter Lens Assembly

#### ⚠ WARNING

The welding headgear is supplied without a welding filter lens. An appropriate welding filter lens must be installed before this system may be used for welding operations. Failure to do so may result in serious eye injury.

#### Removal

The plastic anti-spatter cover lens and welding filter lens may be removed from the lens aperture without removing the welding shield from the headgear. Remove the filter lens, anti-spatter cover lens, and lens gasket from the lens aperture by removing the welding lens retaining clip and easing off the lens gasket.

#### Replacement

Fit the plastic anti-spatter cover lens into the lens gasket. Place the welding filter lens behind the lens and gasket. Push the welding lens retaining clip into place so that all lens components are secured. (Figure 4)

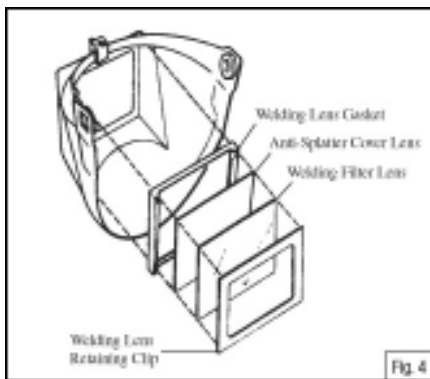

## Welding Shield Assembly

### Removal

Remove the two knobs, hex head bolts, foam gaskets and outer ratchet plates from the headgear. Ease the welding shield off the supports.

### Replacement

Engage the outer ratchet plate grooves with the inner ratchet plate ribs as shown. Replace and tighten the knobs.

## Visor Surround

### Removal

Remove the welding shield and faceseal as described above. Ease the visor surround off the supports.

### Replacement

Hold the visor surround in the raised position and place it over the supports on the headgear shell. Refasten the visor surround to the headgear shell.

## Visor



Incorrect fitting of the visor will reduce face, eye and respiratory protection, and may result in the risk of serious bodily injury or death.

### Removal

Grip the upper edge of the visor surround at the center in one hand and the lower edge in the other hand. Spread the edges apart and pop the visor from the center lugs of the visor surround. Gently push the visor outward from the remaining lugs until it is completely released from the visor surround.

### Replacement

Remove the protective covering from the new visor. With the longest edge toward the top of the visor surround, slide the visor through lugs 1 and 2 as shown in figure 5. Continue sliding the visor so that it rests in the three side lugs (3, 4 and 5) on the same side of the visor surround. Flex the visor downward and insert under the upper, center lug (6) as shown in figure 6. Do not insert the visor under the lower, center lug (12) yet. Flex the visor by pinching from top to bottom and insert under lugs 7 and 8 as shown in figure 7. Push the visor under lugs 9, 10 and 11 one at a time with your thumb as shown in figure 8. Grip the lower edge of the visor surround at the center and twist downward until the visor can be inserted

under the lower, center lug (12) as shown in figure 9. Check that the visor is secured in all 12 positions and there are no gaps at the visor periphery.

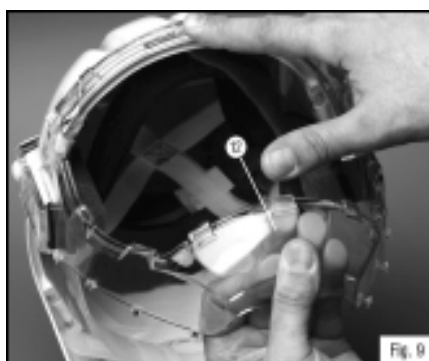
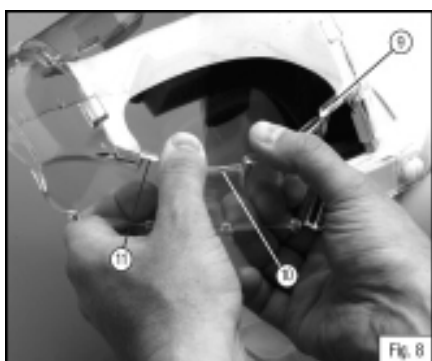
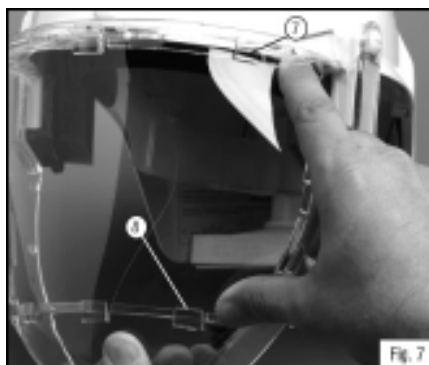
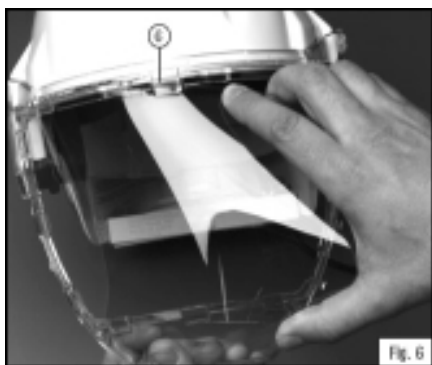
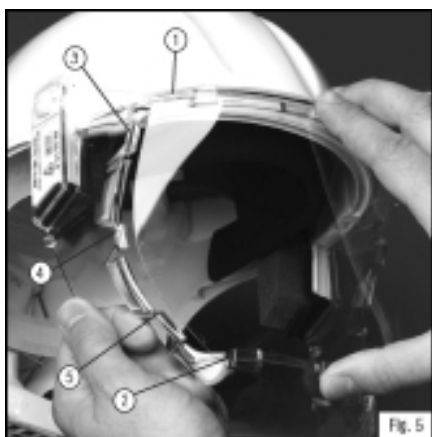

### **Neck Protector Removal**

Peel the neck protector from the hook and loop fastener tabs on the inside of the headgear.

### **Replacement**

Position the neck protector so the elastic band faces inside the headgear. Fasten the corresponding hook and loop sections on each side inside the headgear.

### **Comfort Band**

#### **Removal**

Remove the faceseal as described above. Peel the hook and loop fasteners at each end of the comfort band, and unfold the comfort band from the headband.

#### **Replacement**

Wrap the comfort band (with the slits opening down) around the front of the headband. Refasten the hook and loop tabs so they are on the outside of the headband.

### **Headband and Cradle Assembly**

#### **Removal**

Pull each of the four retaining anchors on the cradle assembly upward from its slot in the headgear. Unbutton the headband at the four slots attaching it to the cradle assembly.

#### **Replacement**

Lay the cradle assembly upside down on the work surface noting the orientation as determined by the letters molded on the cradle retaining buttons (F = Front, B = Back). Place the headband on top of the cradle assembly in the same orientation. The size-adjustment buckle belongs in the back. (Figure 10) Insert the four buttons into the appropriate height adjustment slot from the inside so that the head of the button ends up on the outside of the headband. (Figure 11)

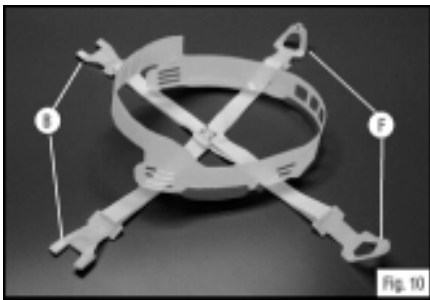

Ensure that all anchors are firmly in place, that the cradle assembly straps are not twisted and are of equal length. (Figure 12) Push each of the four retaining anchors on the cradle assembly into its corresponding slot in the headgear. (Figure 13)

### **⚠ WARNING**

Incorrect fitting of the headband and cradle assembly will reduce head protection and could possibly render the headgear totally ineffective, resulting in serious bodily injury or death.

---

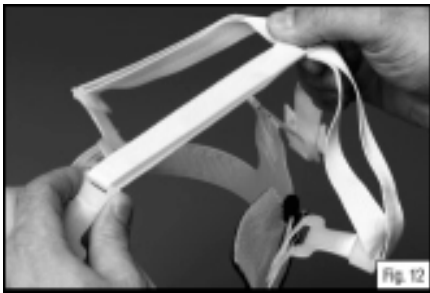

## **Headseal**

### **Removal**

Remove the cradle assembly as described above. The headseal is retained by three anchors - one at each side and one in the center of the headgear. Lift the side lugs up from their headgear shell anchors and remove the central lug from its aperture.

### **Replacement**

Fit the central lug into its aperture in the headgear shell. Push both side lugs into their respective headgear anchor positions. Ensure all three anchor points are properly connected so the headseal remains in contact with the headgear.

## **Temple Seals**

### **Removal**

Remove the headseal as described above. Pull the temple seals away from the headseal.

### **Replacement**

Remove the protective covering from the self-adhesive side of the temple seals and press the seals firmly against the headseal. Note that the temple seals are left-and right-handed. Ensure they are positioned properly against the headseal.

## **Ratchet Pivot Support**

### **Removal**

Completely disassemble the headgear until only the headgear shell with pivot supports and retainers remain. (Figure 14) Find the pivot support retainer located on the outside of the headgear shell. With a flat-tip screwdriver, pry the pivot support retainer off to separate the pivot support from the headgear shell.

### **Replacement**

Insert the pivot support through the headgear shell aperture with the tab facing downward in the faceseal groove. Apply gentle pressure to the outside of the faceseal groove to get the pivot support past the narrow part of the opening.



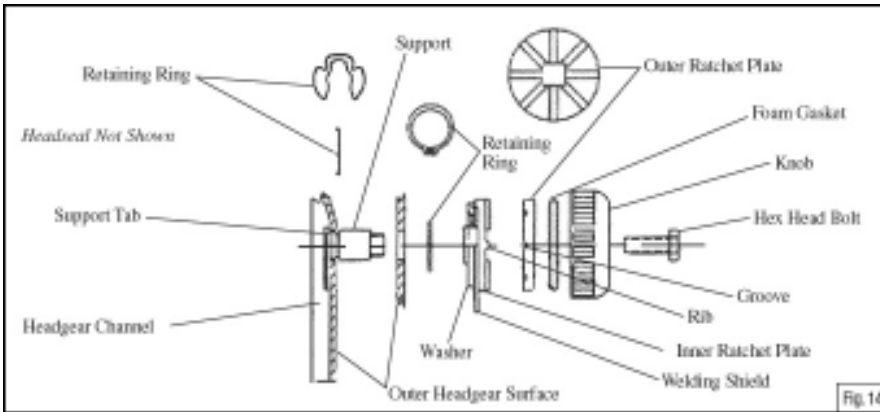

**Flowstream Valve Assembly, Sintered Bronze Disk**

The sintered bronze disk should be replaced when debris has accumulated, when the disk is cracked or when it is otherwise damaged. Damaged disks must be replaced **before** the flowstream valve may be used.

**Removal**

Using snap-ring pliers, remove the internal retaining ring and lift out the sintered bronze disk.

**Replacement**

Insert the new sintered bronze disk into the flowstream valve assembly with the smooth side resting against the smaller threads and the rough side fully visible. Compress the retaining ring and insert it snugly against the rough side of the disk. (Figure 15)

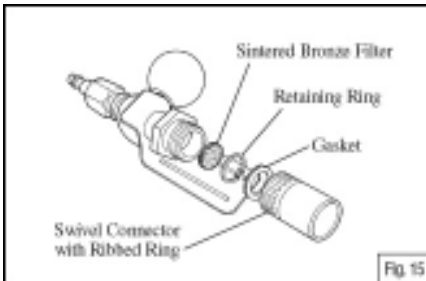

**Donning the System**

The adjustable headband and cradle assembly provide maximum comfort around your head and maintains proper balance in all directions. Adjust the headband and cradle assembly for head size and proper fit of the faceseal as follows:

1. Squeeze both edges of the buckle (rear of the headband) and open the headband fully. (Figure 16)
2. Put the headgear assembly on your head and pull the free end of the headband through the buckle until a secure and comfortable fit is obtained. (Figure 17)

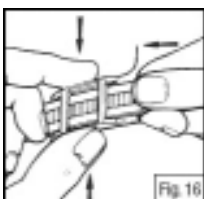

3. The headgear's position on your head may be changed by relocating the buttons in the slots connecting the cradle assembly to the headband. These should be adjusted so the lower edge of the faceseal rests as far below your chin as possible. The headgear should sit level on your head with the faceseal gently hugging your face. After adjusting the headband/cradle assembly, make sure the visor is down and covering your face (the visor surround will “click” over the visor restraint button and be locked down).

**Note:** The faceseal must be pulled as far as possible under your chin after the visor surround is closed over your face.

## WARNING

These respirators do not provide eye or face protection, when exposed to eye and face hazards, you must wear eye and/or face protection appropriate to the hazard. Failure to do so may result in serious bodily injury or death.

---

## WARNING

Incorrectly fitting the headband/cradle assembly may reduce head protection provided by the headgear, resulting in serious bodily injury or death.

---

These headgears should not be used where the surface temperature of the headgear will exceed 130° F (54° C). Head protection will degrade if the headgear is exposed to higher temperatures.

Check with your safety professional to be sure that the headgear assembly provides adequate splash protection in your work environment.

Adjust the headgear to fit comfortably, and ensure the breathing tube is not twisted when the complete system has been donned. Connect and turn on air supply.

### **Connecting the Headpiece to the PAPR Filtration/Blower Unit or Supplied Air System**

The 3M™ R-Series Welding Headgear must be combined with one of the following powered air purification (PAPR) waist mounted filtration/blower units or supplied air systems to form a complete positive pressure respirator system.

## WARNING

The user must read and follow all *User Instructions* supplied with the PAPR motor blower or supplied air equipment. Incorrect operation of the PAPR motor blower or supplied air system could result in reduced airflow, interruption of airflow to the headpiece or contamination of breathing air and may result in sickness or death.

---

### **Breathe Easy™ Turbo and Airstream™ Motor Blowers (Breathe Easy™ 1, AH3, AH3B, AH3-1 and AH3-1B Headgear Systems)**

## WARNING

Read and follow the *User Instructions* supplied with the PAPR blower unit. Complete the pre-use inspection and user performance test specified by the PAPR *User Instructions* before attaching the PAPR motor blower to the headpiece. Failure to do so may result in sickness or death.

---

Place the hose clamp onto the free end of the breathing tube. Slide that end of the breathing tube over the PAPR blower unit outlet and tighten the clamp. Ensure that the breathing tube is secured to the turbo PAPR blower unit outlet and that the end of the breathing tube is visible between the turbo PAPR blower unit and the hose clamp.

**Supplied Air Systems (AH31 Flowstream, AH33 Vorstream, and AH39 Coldstream)**

Before connecting the breathing tube to the valve/tube assembly, make sure a gasket is fitted into the ribbed ring of the breathing tube. Place the ribbed ring of the breathing tube assembly onto the threaded coupling of the valve/tube assembly. Hand-tighten the ribbed ring clockwise to secure the breathing tube to the valve/tube assembly.

## SECTION 5

### Operating Instructions



Use of these respirators by untrained or unqualified persons, or use not in accordance with these *User Instructions* may adversely affect respirator performance and result in sickness or death. Refer to additional warnings listed in the Safety Guidelines Section.

Use of these respirators must be in accordance with applicable safety and health standards, respirator selection tables contained in such publications as ANSI Z88.2-1992, or pursuant to the recommendations of an industrial hygienist. A written respirator program must be in place, which is in accordance with the OSHA respiratory protection standard found in 29 CFR 1910.134 prior to using any respirator.

Before use, the user must be trained by the employer in the proper use and maintenance of the 3M R-Series welding headgear respirator. Such training must be in accordance with these *User Instructions*. Each person using these respirators must first read and understand these entire *User Instructions*. Failure to do so may result in sickness or death.

The welding shield of the 3M R-Series welding headgear is not designed to be raised or lowered by nodding the head. Using the 3M R-Series welding headgear in this manner can result in neck injury and can damage the ratchet pivot system.

The 3M R-Series welding headgear is not designed for use in arc-air welding or other high-heat applications.

Always don the respirator in a non-contaminated area. Failure to properly don this respirator before entering a hazardous atmosphere may result in sickness or death.

Before you enter a hazardous atmosphere wearing this respirator, you must inspect the respirator, complete a user performance check, and don the respirator according to the instructions in the Assembly Section. Failure to do so may affect respirator performance and may result in sickness or death. Do not wear this respirator headpiece to enter areas where atmospheric concentrations of contaminants are unknown, immediately dangerous to life or health, exceed the Maximum Use Concentration (MUC\*) for the respirator system, or where atmospheres contain less than 19.5% oxygen.

\*MUC is equal to the respirator's Assigned Protection Factor (25) times the Permissible Exposure Limit for the contaminant.

Breathing air must meet at least the specification for Grade D breathing air, as described in the Compressed Gas Association Commodity Specification G-7.1-1989 in the United States and Table 2 of the CSA standard CAN3-Z180.1-M85 in Canada.

Airline couplings shall be incompatible with outlets for other gas systems to prevent inadvertent servicing of airline respirators with nonrespirable gases or oxygen in accordance with OSHA standard 29 CFR 1910.134(d)(3). Failure to do so may result in sickness or death.

If the respirator fails any of the requirements of the user inspection and performance check, do not use the respirator until all necessary repairs have been made and the respirator passes the performance check. Failure to do so may adversely affect respirator performance and result in sickness or death.

---

If you have any doubts about the applicability of the equipment to your job situation, consult an industrial hygienist or call the technical service department of 3M OH&ESD at 1-800-243-4630. In Canada, call Marketing at 1-800-265-1840, ext. 6137 or Technical Service at 1-800-267-4414.

### User Performance Check

1. Observe the condition of the breathing tube in the air inlet at the back of the headgear. Verify that the air inlet is not twisted or obstructed in any way.
2. There are no holes, breaks, cracks, tears, or other damage in the breathing tube or air supply hoses.
3. Place your hand inside the facepiece, in the area above the faceshield. You should feel the air entering the headgear.
4. Verify that the respirator is connected to the air supply and that air is flowing before donning the headgear.
5. With the respirator in operation and donned according to the instructions in the Assembly Section, enter the contaminated area, breathing normally. Keep all respirator system components away from equipment, vehicles and other physical and chemical hazards.

## WARNING

Do not remove the respirator while you are in a hazardous atmosphere. Contaminants which are dangerous to your health include those which you may not be able to see or smell. Failure to do so may result in sickness or death. Leave the contaminated area immediately if:

- Any part of the system becomes damaged
- Airflow into the respirator decreases or stops
- Breathing becomes difficult
- You feel dizzy or your vision is impaired
- You taste or smell contaminants
- Your face, eyes, nose or mouth become(s) irritated
- You suspect that the concentration of contaminants may have reached levels at which this respirator may no longer provide adequate protection.

Remove the respirator in a clean area. Clean your hands of any contaminants before reaching inside the facepiece for any reason. Refer to the Cleaning and Inspection Section for cleaning, inspection and storage information.

---

### Airline Systems Only

Verify the valve/tube assembly is not damaged or clogged; and all quick-disconnect locations are secure.

Read the pressure gauge located where you are attaching the compressed air hose to the source of breathing air to verify that the pressure is within the approved range. Adjust the pressure, as needed, within that range.

<b>Flowstream</b>	55-70 psig
<b>Vorstream</b>	75-120 psig
<b>Coldstream</b>	70-115 psig

Connect the valve/tube assembly to the air supply hose by pulling back the spring-loaded collar of the female coupling on the air supply hose, inserting and retaining the male quick-disconnect plug, and releasing the collar. Connect the other end of the air supply hose to your source of Grade D (or better) breathing air.

### Adjust airflow for your ST System as follows

#### Flowstream

Adjust airflow by turning the black knob on the flowstream valve. A clockwise rotation reduces airflow; a counterclockwise rotation increases airflow.

**Vorstream**

Adjust temperature by  $\pm 45^{\circ}\text{ F}$  ( $\pm 25^{\circ}\text{ C}$ ) from ambient by moving the temperature control lever on the vorstream tube to the right or left.

Handle the vorstream tube carefully when air is flowing through the system. The tube may be hot or cold to the touch. The vorstream tube comes attached to a pad. Be sure to wear this pad next to your body.

**Coldstream**

Cool airflow a maximum of  $45^{\circ}\text{ F}$  ( $25^{\circ}\text{ C}$ ) from ambient by rotating the collar on the coldstream tube counterclockwise.

Handle the coldstream tube carefully when air is flowing through the system. The body and end of the tube may be hot to the touch. The coldstream tube comes attached to a pad. Be sure to wear this pad next to your body.

**Adjusting the Belt Length**

The valve/tube assembly is shipped already attached to the belt so that it will lie perpendicular to the belt when it is worn. Slide the metal adjustment buckle along the belt for a secure, comfortable fit. Fasten the belt at the front.

**Compressor Requirements for the Airline Systems**

	<b>CFM Required</b>	<b>CFM Delivered</b>	<b>Pressure Range</b>	<b>Maximum Number of Hoses</b>	<b>Maximum Hose Length</b>
<b>Flowstream</b>	15	6 to 15	55-70 psig	6	300
<b>Vorstream</b>	25	6 to 12	75-120 psig	4	100
<b>Coldstream</b>	15	6 to 12	70-115 psig	4	100

## SECTION 6

### Inspection and Cleaning

After each use, clean and inspect headgear assembly to identify signs of damage or wear that may affect performance of the respirator and reduce the degree of protection provided. For a list of replacement parts, refer to the System Components and Replacement Parts Section. The Troubleshooting Section contains a troubleshooting guide to help you identify the proper action to take for specific problems that may be detected.

#### WARNING

If excessive wear and/or damage to the respirator or its components is observed at any time, do not use the respirator until all necessary repairs have been made and the wearer has successfully completed the user performance check described in the Operating Instructions Section. Failure to do so may result in sickness or death.

---

### Cleaning the 3M™ R-Series Welding Headgear

Follow the hygiene practices established by your employer for the specific contaminants to which you have been exposed. To remove paint or other coatings from the faceshield, you may wipe the faceshield with mineral spirits.

### Inspecting the 3M R-Series Welding Headgear

#### WARNING

Do not clean headgears with detergents that contain lanolin or other oils since they may soften or distort the faceshield.

Do not wipe the faceshield with strong solvents such as MEK, acetone, toluene, as those may damage or distort the faceshield.

Do not soak headgears or components in cleaning solutions or solvents.

Misuse may adversely affect respirator performance and may result in sickness or death.

---

Visually examine the condition of the headgear shell, head suspension, faceshield, breathing tube and air supply equipment after each use.

### Headgear

#### WARNING

If you discover any of the wear and damage described below, discard the component and replace it with a new one. Failure to do so may adversely affect respirator performance and result in sickness or death.

---

Check that there are no dents or cracks in the headgear assembly. Look closely at the faceseal fabric and stitching. There should be no tears or loss of elasticity of the elastic band that could permit contaminated air to enter the headgear. Check that the headseal, temple seals are in good condition.

**Faceshield**

Check the faceshield for correct placement in the visor surround. Also look for scratches or other visual distortions that make it difficult to see through the faceshield.

**Breathing Tube**

Carefully examine the entire breathing tube. Look for tears, holes or cracks. Bend the tube to verify that it is flexible.

**Storage**

Store your headgear at room temperature in a dry area that is protected from exposure to hazardous contaminants.



## SECTION 7

### Troubleshooting

Use the table below to help identify possible causes and corrective action for problems you may experience.

<b>Problem</b>	<b>Possible Causes</b>	<b>Corrective Action</b>
Poor visibility through faceshield	Faceshield is scratched or coated with debris	Remove cover and replace Wipe debris off Replace visor Consider using faceshield covers
Breathing tube pulls headgear out of comfortable position	Breathing tube too long Breathing tube too short	Select appropriate length breathing tube (14 in and 17 1/2 in lengths are available)
Headgear noisy	Twisted breathing tube inlet	Assure that the breathing tube is securely fastened to the headgear and is not twisting the inlet opening.
Low airflow	Breathing tube disconnected at hood or at control device  Compressed air hose disconnected at control device or at air source  Air pressure too low	Reattach tube  Reconnect each end of the hose  Check pressure where hose is attached to source. Increase pressure within approved range.  Check condition of compressed air filters. Replace dirty, loaded filters.
Temperature of air from airline is too warm or too cold	Change in ambient air temperature at air source  Vorstream or coldstream control misadjusted  Air pressure too low	Cool breathing air with vorstream or coldstream cooling assembly  Warm breathing air with vorstream assembly  Re-adjust for desired temperature and flow  Raise air pressure (within the approved range) for more heating/cooling

## SECTION 8

### Important Notice:

**LIMITATION OF LIABILITY:** 3M shall not be liable or responsible for any loss or damage, whether direct, indirect, incidental, special or consequential, arising out of sale, use or misuse of 3M OH&ESD products, or the user's inability to use such products. THE REMEDIES SET FORTH HEREIN ARE EXCLUSIVE.

**FOR MORE INFORMATION** and assistance on 3M occupational health and environmental safety products, contact your local 3M representative or call 3M OH&ESD Technical Service toll free in U.S.A., 1-800-243-4630. In Canada, call Marketing at 1-800-265-1840, ext. 6137 or Technical Service at 1-800-267-4414.

### 3M Occupational Health and Environmental Safety Division

3M Center, Building 235-2W-01  
P.O. Box 33010  
St. Paul, MN 55133-3010

*Nomex® is a registered trademark of DuPont.  
Sontara® is a registered trademark of DuPont.  
Tyvek® is a registered trademark of DuPont.*



**Calle San Ignacio de Loyola 271, Miraflores  
Lima - Perú**



**617 - 1212 Fax: 617 - 1213**



**[www.prosac.com.pe](http://www.prosac.com.pe)**



**[postmaster@prosac.com.pe](mailto:postmaster@prosac.com.pe)**